

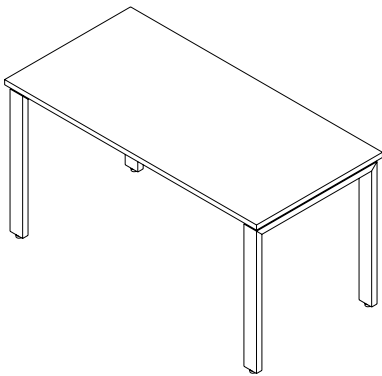

especificações técnicas

gerência e staff



Mesa Retangular

PLU7001 - 800x600x730
 PLU7024 - 1200x600x730
 PLU7003 - 1400x600x730
 PLU7022 - 1600x600x730
 PLU7026 - 800x700x730
 PLU7027 - 1200x700x730
 PLU7028 - 1400x700x730
 PLU7029 - 1600x700x730
 PLU7600 - 1800x700x730
 PLU7025 - 1200x800x730
 PLU7004 - 1400x800x730
 PLU7023 - 1600x800x730
 PLU7601 - 1800x800x730

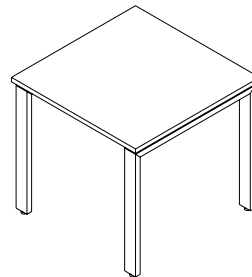

Mesa Quadrada

PLU7002 - 800x800x730

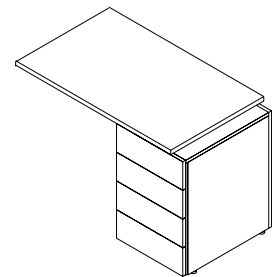

Mesa lateral com gaveteiro pedestal para acoplar e mesas com tampo fixo

PLU7388 - 800x600x730
 PLU7389 - 1000x600x730

Gaveteiros opcionais:

04 gavetas
 02 gavetas e 01 gaveta para pasta
 01 gaveta e 01 porta

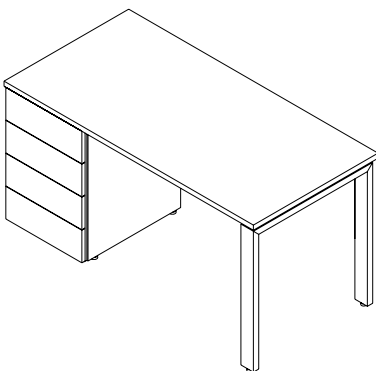

Mesa escrivaninha com gaveteiro pedestal

PLU7310 - 1400x700x730
 PLU7311 - 1600x700x730
 PLU7312 - 1800x700x730
 PLU7313 - 1400x800x730
 PLU7314 - 1600x800x730
 PLU7315 - 1800x800x730
Gaveteiros opcionais:
 04 gavetas
 02 gavetas e 01 gaveta para pasta
 01 gaveta e 01 porta

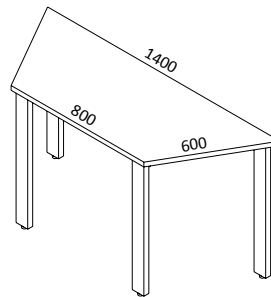

Mesa trapezoidal

PLU7005 - 1400x520x730

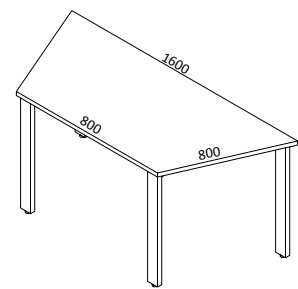

Mesa trapezoidal

PLU7006 - 1600x693x730

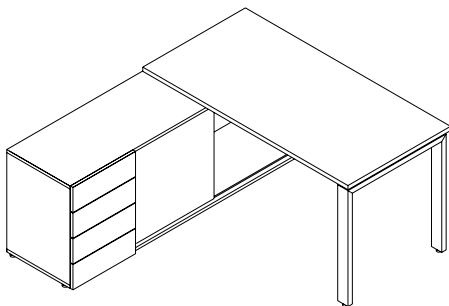

**Mesa Gerente com Armário Credenza
Gavetas, Porta de Correr e Nicho Aberto
para Subida da Fiação e Instalação da
CPU**

PLU7354 - 1400x700/1700x482x730
 PLU7355 - 1600x700/1700x482x730
 PLU7356 - 1800x700/1700x482x730
 PLU7357 - 1400x800/1700x482x730
 PLU7358 - 1600x800/1700x482x730
 PLU7359 - 1800x800/1700x482x730

Gaveteiros opcionais:

04 gavetas
 02 gavetas e 01 gaveta para pasta
 01 gaveta e 01 porta

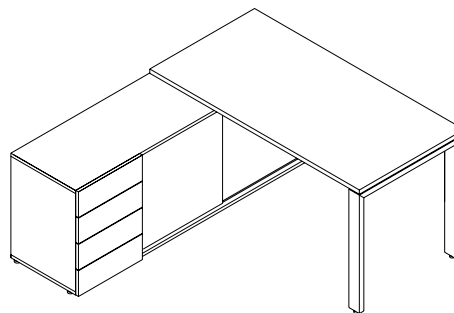

**Mesa Gerente com Armário Credenza
Gavetas, Portas de Correr Parte Interna
com Subida para Fiação**

PLU7362 - 1400x700/1700x482x730
 PLU7363 - 1600x700/1700x482x730
 PLU7364 - 1800x700/1700x482x730
 PLU7365 - 1400x800/1700x482x730
 PLU7366 - 1600x800/1700x482x730
 PLU7367 - 1800x800/1700x482x730

Gaveteiros opcionais:

04 gavetas
 02 gavetas e 01 gaveta para pasta
 01 gaveta e 01 porta

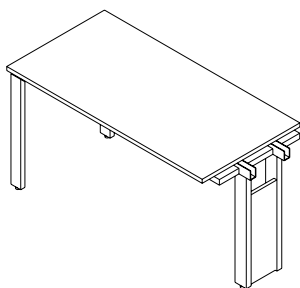

**Plataforma Mono-Face
(Início de Fileira)**

PLU7173 - 1200x700x730
 PLU7174 - 1400x700x730
 PLU7175 - 1600x700x730
 PLU7602 - 1800x700x730
 PLU7176 - 1200x800x730
 PLU7177 - 1400x800x730
 PLU7178 - 1600x800x730
 PLU7603 - 1800x800x730

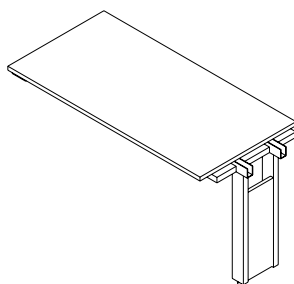

**Plataforma Mono-Face
(Meio de Fileira)**

PLU7182 - 1200x700x730
 PLU7183 - 1400x700x730
 PLU7184 - 1600x700x730
 PLU7604 - 1800x700x730
 PLU7185 - 1200x800x730
 PLU7186 - 1400x800x730
 PLU7187 - 1600x800x730
 PLU7605 - 1800x800x730

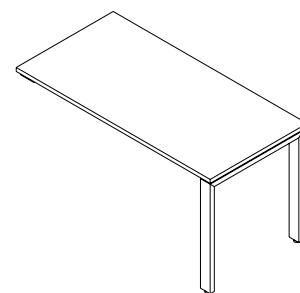

**Plataforma Mono-Face
(Final de Fileira)**

PLU7191 - 1200x700x730
 PLU7192 - 1400x700x730
 PLU7193 - 1600x700x730
 PLU7606 - 1800x700x730
 PLU7194 - 1200x800x730
 PLU7195 - 1400x800x730
 PLU7196 - 1600x800x730
 PLU7607 - 1800x800x730

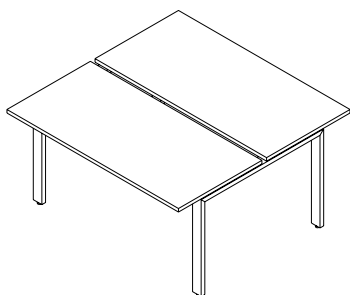

**Plataforma dupla-face
(auto-portante)**

PLU7630 - 1200x1400x730
 PLU7631 - 1400x1400x730
 PLU7632 - 1600x1400x730
 PLU7633 - 1800x1400x730
 PLU7634 - 1200x1600x730
 PLU7635 - 1400x1600x730
 PLU7636 - 1600x1600x730
 PLU7637 - 1800x1600x730

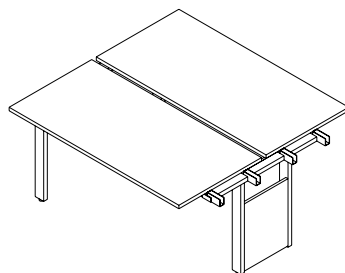

**Plataforma dupla-face
(início de fileira)**

PLU7638 - 1200x1400x730
 PLU7639 - 1400x1400x730
 PLU7640 - 1600x1400x730
 PLU7641 - 1800x1400x730
 PLU7642 - 1200x1600x730
 PLU7643 - 1400x1600x730
 PLU7644 - 1600x1600x730
 PLU7645 - 1800x1600x730

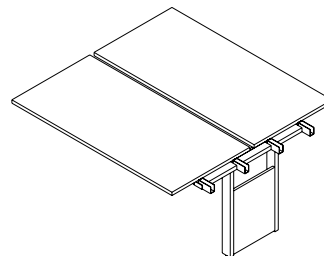

**Plataforma dupla-face
(meio de fileira)**

PLU7646 - 1200x1400x730
 PLU7647 - 1400x1400x730
 PLU7648 - 1600x1400x730
 PLU7649 - 1800x1400x730
 PLU7650 - 1200x1600x730
 PLU7651 - 1400x1600x730
 PLU7652 - 1600x1600x730
 PLU7653 - 1800x1600x730

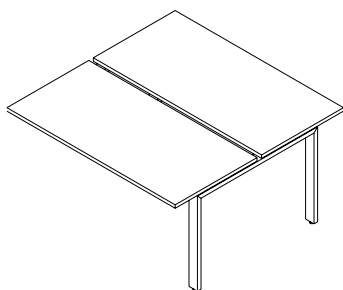

**Plataforma dupla-face
(final de fileira)**

PLU7654 - 1200x1400x730
 PLU7655 - 1400x1400x730
 PLU7656 - 1600x1400x730
 PLU7657 - 1800x1400x730
 PLU7658 - 1200x1600x730
 PLU7659 - 1400x1600x730
 PLU7660 - 1600x1600x730
 PLU7661 - 1800x1600x730

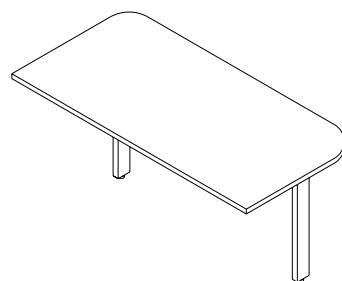

**Terminal para acoplar em
plataforma com tampo fixo**

PLU7680 - 1400x700x730
 PLU7681 - 1600x700x730
 PLU7682 - 1400x800x730
 PLU7683 - 1600x800x730

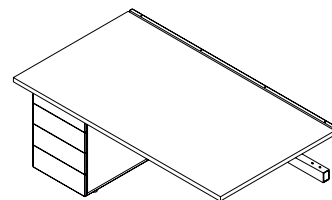

**Plataforma mono-face
tampo retrátil com gavetei-
ro pedestal (início e meio
de fileira)**

PLU7316 - 1400x677x730
 PLU7317 - 1600x677x730
 PLU7318 - 1800x677x730
 PLU7319 - 1400x777x730
 PLU7320 - 1600x777x730
 PLU7321 - 1800x777x730

Gaveteiros opcionais:

04 gavetas
 02 gavetas e 01 gaveta para pasta
 01 gaveta e 01 porta

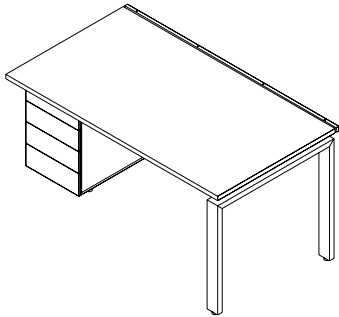

**Plataforma mono-face
tampo retrátil com gaveteiro
pedestal (individual e final
de fileira)**

PLU7322 - 1400x677x730
 PLU7323 - 1600x677x730
 PLU7324 - 1800x677x730
 PLU7325 - 1400x777x730
 PLU7326 - 1600x777x730
 PLU7327 - 1800x777x730

Gaveteiros opcionais:

04 gavetas
 02 gavetas e 01 gaveta para pasta
 01 gaveta e 01 porta

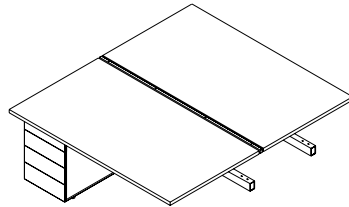

**Plataforma dupla-face tampo
retrátil com gaveteiro pedestal
(início e meio de fileira)**

PLU7328 - 1400x1400x730
 PLU7329 - 1600x1400x730
 PLU7330 - 1800x1400x730
 PLU7331 - 1400x1600x730
 PLU7332 - 1600x1600x730
 PLU7333 - 1800x1600x730

Gaveteiros opcionais:

04 gavetas
 02 gavetas e 01 gaveta para pasta
 01 gaveta e 01 porta

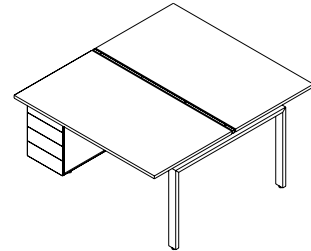

**Plataforma dupla-face
tampo retrátil com gaveteiro
pedestal (individual
final de fileira)**

PLU7334 - 1400x1400x730
 PLU7335 - 1600x1400x730
 PLU7336 - 1800x1400x730
 PLU7337 - 1400x1600x730
 PLU7338 - 1600x1600x730
 PLU7339 - 1800x1600x730

Gaveteiros opcionais:

04 gavetas
 02 gavetas e 01 gaveta para pasta
 01 gaveta e 01 porta

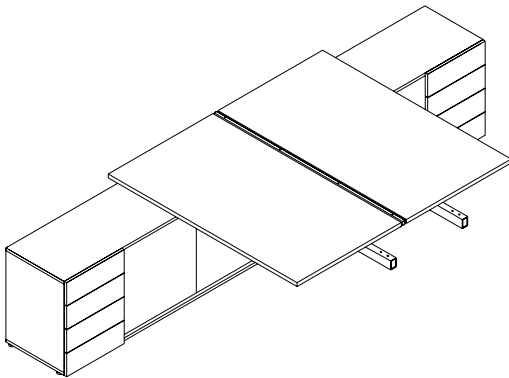

**Plataforma dupla-face tampo retrátil com
armário credenza gavetas, porta de correr e
nicho aberto para subida da fiação e instalação
da CPU**

(Início e Meio de Fileira)

PLU7340 - 1400x1400/3400x730
 PLU7341 - 1600x1400/3400x730
 PLU7342 - 1800x1400/3400x730
 PLU7343 - 1400x1600/3400x730
 PLU7344 - 1600x1600/3400x730
 PLU7345 - 1800x1600/3400x730

Gaveteiros opcionais:

04 gavetas
 02 gavetas e 01 gaveta para pasta
 01 gaveta e 01 porta

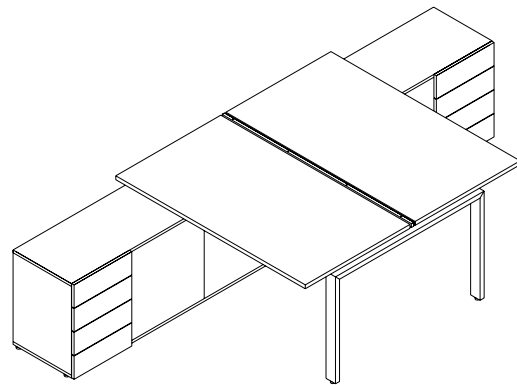

**Plataforma dupla-face tampo retrátil com
armário credenza gavetas, porta de correr e
nicho aberto para subida da fiação e instalação
da CPU**

(Individual e Final de Fileira)

PLU7346 - 1400x1400/3400x730
 PLU7347 - 1600x1400/3400x730
 PLU7348 - 1800x1400/3400x730
 PLU7349 - 1400x1600/3400x730
 PLU7350 - 1600x1600/3400x730
 PLU7351 - 1800x1600/3400x730

Gaveteiros opcionais:

04 gavetas
 02 gavetas e 01 gaveta para pasta
 01 gaveta e 01 porta

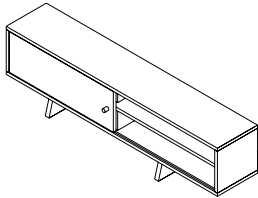

Nicho suspenso com porta de correr para plataforma mono-face com tampo fixo, mesas e escrivaninhas com prof. de 800mm

PLU7690 - 1200x296x276
 PLU7691 - 1400x296x276
 PLU7692 - 1600x296x276
 PLU7693 - 1800x290x276

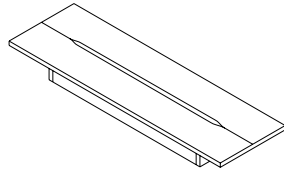

Apoio para vídeo para plataforma com tampo fixos com ou sem calha basculante

PLU7070 - 1200x400x155
 PLU7071 - 1400x400x155
 PLU7072 - 1600x400x155
 PLU7616 - 1800x400x155

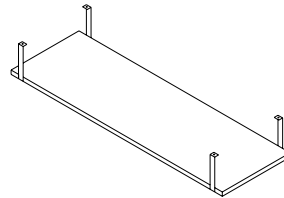

Prateleira central suspenso para CPU, estabilizadores e nobreak utilizada em plataformas dupla-face com tampo retrátil

PLU7459 - 825x420x200
 PLU7460 - 1025x420x200
 PLU7461 - 1225x420x200

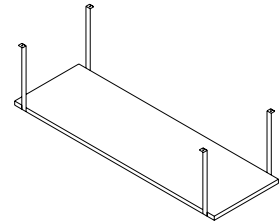

Prateleira central suspenso para CPU, estabilizadores e nobreak utilizada em plataformas dupla-face com tampo fixo

PLU7113 - 1050x450x350
 PLU7114 - 1250x450x350
 PLU7115 - 1450x450x350
 PLU7617 - 1650x450x350

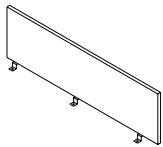

Painel sup. frontal sem frisos para bancada dupla face com tampo fixo

PLU7394 - 1000x290x25
 PLU7395 - 1200x290x25
 PLU7396 - 1400x290x25
 PLU7397 - 1600x290x25

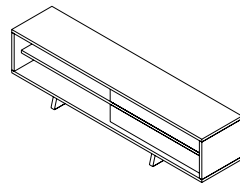

Nicho suspenso aberto para plataforma dupla-face com tampo fixo

PLU7380 - 1200x296x276
 PLU7381 - 1400x296x276
 PLU7382 - 1600x296x276
 PLU7383 - 1800x296x276

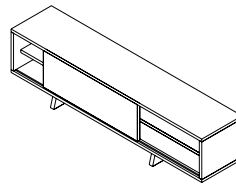

Nicho suspenso para plataforma dupla-face com tampo fixo com porta de correr

PLU7384 - 1200x296x276
 PLU7385 - 1400x296x276
 PLU7386 - 1600x296x276
 PLU7387 - 1800x296x276

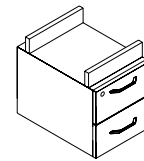

Gaveteiro suspenso para tampo fixo

PLU3334 - 330x450x305

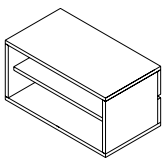

Nicho para mesas e escrivaninhas com tampo fixo

PLU7371 - 600x350x290
 PLU7372 - 700x350x290
 PLU7373 - 800x350x290
 PLU7374 - 677x350x290
 PLU7375 - 777x350x290

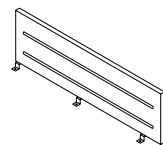

Painel sup. frontal com frisos para plataforma dupla face com tampo fixo

PLU7390 - 1000x290x25
 PLU7391 - 1200x290x25
 PLU7392 - 1400x290x25
 PLU7393 - 1600x290x25

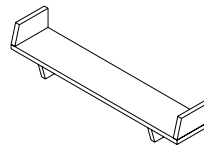

Apoio para vídeo para mesas e plataforma com tampo fixos ou retrátil

PLU7376 - 900x220x250
 PLU7377 - 1100x220x250
 PLU7378 - 1300x220x250
 PLU7379 - 1500x220x250

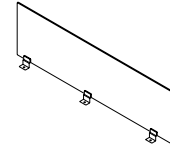

Painel sup. frontal para bancada dupla face com tampo fixo (vidro/metacrilato)

PLU7398 - 1000x290x06
 PLU7399 - 1200x290x06
 PLU7400 - 1400x290x06
 PLU7401 - 1600x290x06

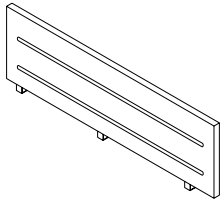

Painel sup. frontal com frisos para mesas e escrivaninha com tampo fixo

PLU7414 - 400x290x25
 PLU7415 - 600x290x25
 PLU7416 - 800x290x25
 PLU7417 - 1000x290x25
 PLU7418 - 1200x290x25
 PLU7419 - 1400x290x25
 PLU7420 - 1600x290x25

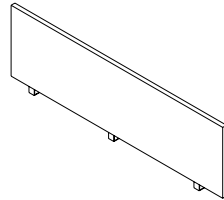

Painel sup. frontal sem frisos para mesas e escrivaninha com tampo fixo

PLU7421 - 400x290x25
 PLU7422 - 600x290x25
 PLU7423 - 800x290x25
 PLU7424 - 1000x290x25
 PLU7425 - 1200x290x25
 PLU7426 - 1400x290x25
 PLU7427 - 1600x290x25

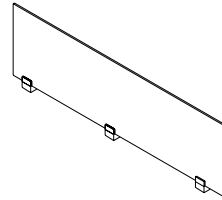

Painel sup. frontal para mesas e escrivaninhas com tampo fixo (vidro/metacrilato)

PLU7428 - 400x290x06
 PLU7429 - 600x290x06
 PLU7430 - 800x290x06
 PLU7431 - 1000x290x06
 PLU7432 - 1200x290x06
 PLU7433 - 1400x290x06
 PLU7434 - 1600x290x06

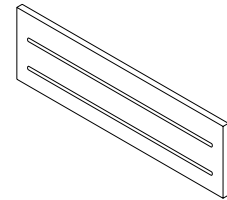

Painel sup. frontal com frisos para plataforma dupla face com tampo retrátil

PLU7403 - 1200x290x25
 PLU7404 - 1400x290x25
 PLU7405 - 1600x290x25

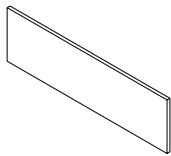

Painel sup. frontal sem frisos para plataforma dupla face com tampo retrátil

PLU7407 - 1200x290x25
 PLU7408 - 1400x290x25
 PLU7409 - 1600x290x25

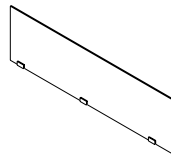

Painel sup. frontal para bancada dupla face

PLU7411 - 1200x290x06
 PLU7412 - 1400x290x06
 PLU7413 - 1600x290x06

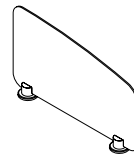

Painel superior lateral para mesa e plataformas com tampo fixo

PLU7435 - 500x290x18
 PLU7436 - 600x290x18
 PLU7437 - 700x290x18

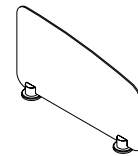

Painel superior lateral para mesa e plataformas com tampo fixo (vidro/metacrilato)

PLU7665 - 500x290x6
 PLU7666 - 600x290x6
 PLU7667 - 700x290x6

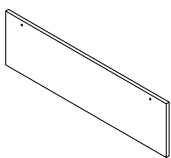

Painel frontal inferior para mesas retangulares e bancadas mono-face

PLU7438 - 650x296x18
 PLU7439 - 850x296x18
 PLU7440 - 1050x296x18
 PLU7441 - 1250x296x18
 PLU7442 - 1450x296x18
 PLU7443 - 1650x296x18

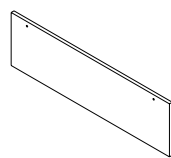

Painel frontal inferior uso mesas escrivaninhas linha Pluri

PLU7447 - 890x296x18
 PLU7448 - 1090x296x18
 PLU7449 - 1290x296x18

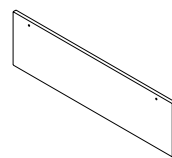

Painel frontal inferior Uso bancadas gerente linha Pluri

PLU7450 - 840x296x18
 PLU7451 - 1040x296x18
 PLU7452 - 1240x296x18

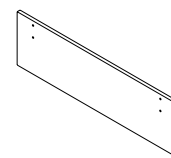

Painel frontal inferior para plataforma mono-face com tampo retrátil

PLU7444 - 1399x296x18
 PLU7445 - 1599x296x18
 PLU7446 - 1799x296x18

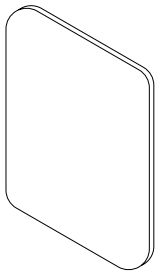

Fechamento alto cantos com raios para mesas e escrivaninhas com tampo fixo

PLU7456 - 1010x800x25
 PLU7457 - 1010x900x25
 PLU7458 - 1010x1000x25

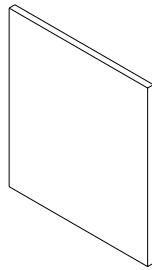

Fechamento Baixo cantos retos para mesas e plataformas mono-face com tampos fixos ou retrátil

PLU7470 - 675x600x25
 PLU7471 - 675x700x25
 PLU7472 - 675x800x25

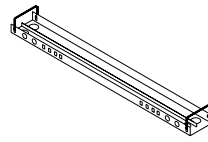

Calhas para mesas e plataforma mono-face com alojamento p/instalações de tomadas

PLU7670 - 650x130x60
 PLU7679 - 850x130x60
 PLU7671 - 1050x130x60
 PLU7672 - 1250x130x60
 PLU7673 - 1450x130x60
 PLU7674 - 1650x130x60

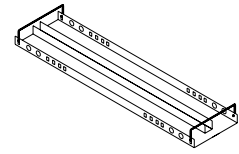

Calhas para plataforma dupla-face com alojamento p/instalações de tomadas

PLU7675 - 1050x350x60
 PLU7676 - 1250x350x60
 PLU7677 - 1450x350x60
 PLU7678 - 1650x350x60

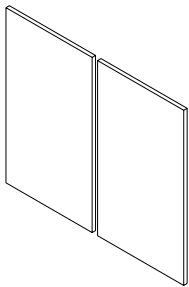

Fechamento alto cantos retos para plataforma dupla-face com tampos fixos ou retrátil

PLU7475 - 1110x1300x25

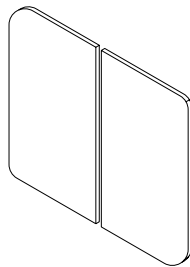

Fechamento alto cantos externos com raios para plataforma dupla-face com tampos fixos ou retrátil

PLU7476 - 1110x1300x25

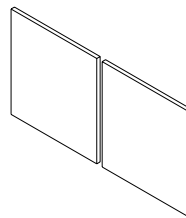

Fechamento Baixo cantos retos para plataforma dupla-face com tampos fixos ou retrátil

PLU7473 - 675x1300x25

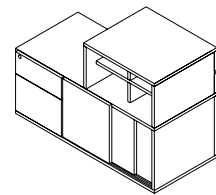

Armazenador híbrido fixo com 01 gaveta e 1 gavetão/portas de correr

PLU7369 - 1000x450x430

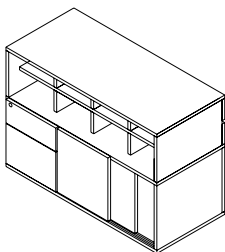

Armazenador escaninho fixo com 01 gaveta e 1 gavetão/portas de correr

PLU7370 - 1000x450x730

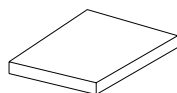

Almofada em tecido/espuma para o armazenador

PLU7478 - 400x400x40

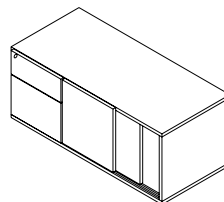

Armazenador fixo com 01 gaveta e 1 gavetão/portas de correr

PLU7368 - 1000x450x430

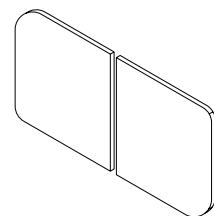

Fechamento Baixo Cantos Externos com Raio para Plataforma Dupla-Face com Tampos Fixos ou Retrátil

PLU7474 - 675x1300x25

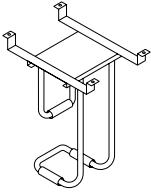

Suporte para CPU tubular cromado giratório (360°) para instalar nos balcões credenza das mesas gerente e plataformas

PLU7477 - 150x300x430

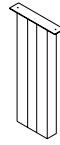

Coluna de fiação para fixar na travessa horizontal do pé utilizado nas mesas, escrivaninhas e plataformas com tampo fixo e retrátil

PLU7100 - 200x60x640



Duto para fiação fixado na travessa vertical do pé utilizado nas mesas, escrivaninhas e plataformas com tampo fixo e retrátil

PLU7101 - 65x30x600

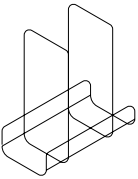

Suporte para CPU aramado para mesas, escrivaninhas e plataformas com tampo fixo ou retrátil

PLU7021 - 210x400x480

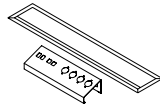

Colarinho com suporte para tomadas

PLU7621 - 740x135

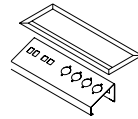

Colarinho com suporte para tomadas

PLU7622 - 350x135

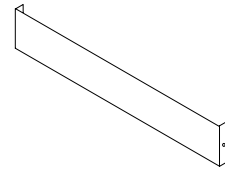

Tampa para fechamento de calhas

PLU7201 - 355x62x12 (Uso em plataforma dupla-face)

PLU7202 - 135x62x12 (Uso em mesas e plataforma mono-face)

Opções de acabamentos para laminados

- Alumini
- Amêndoa
- Argila
- Branco
- Carvalho Prata
- Grafite
- Málaga
- Noce
- Preto
- Wenge

Opções de acabamentos para pintura gofrato

- Bambu
- Cappuccino
- Cítrico
- Stone

Opções de acabamentos para metais

- Alumínio
- Argila
- Branco
- Grafite
- Prata
- Preto

Opções de acabamentos para metacrilato

- Branco
- Castanho
- Goiaba
- Oliva
- Verde

reunião

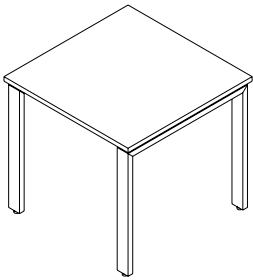

Mesa Quadrada

PLU7002 - 800x800x730

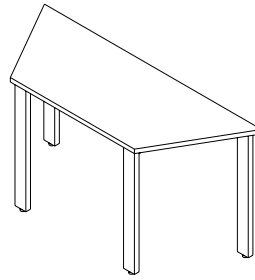

Mesa trapezoidal

PLU7005 - 1400x520x730

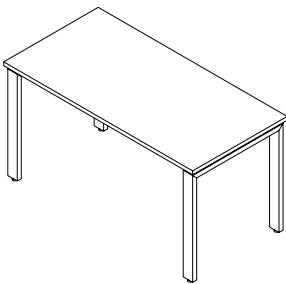

Mesa retangular

PLU7001 - 800x600x730
 PLU7024 - 1200x600x730
 PLU7003 - 1400x600x730
 PLU7022 - 1600x600x730
 PLU7026 - 800x700x730
 PLU7027 - 1200x700x730
 PLU7028 - 1400x700x730
 PLU7029 - 1600x700x730

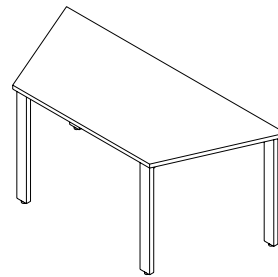

Mesa trapezoidal

PLU7006 - 1600x693x730

Exemplos de layouts de ambientes para reuniões (mesa trapezoidal, mesa quadrada e mesa retangular).



Opções de acabamentos para laminados

- Alumini
- Amêndoa
- Argila
- Branco
- Carvalho Prata
- Grafite
- Málaga
- Noce
- Preto
- Wenge

Opções de acabamentos para metais

- Alumínio
- Argila
- Branco
- Grafite
- Prata
- Preto

coletivos

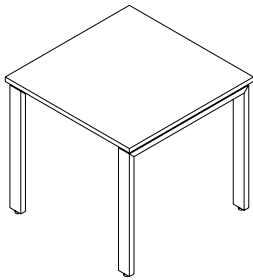

Mesa Quadrada

PLU7002 - 800x800x730

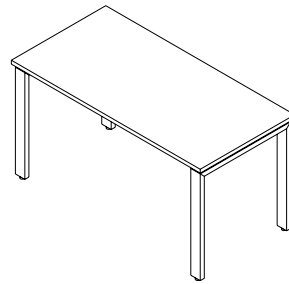

Mesa Retangular

PLU7001 - 800x600x730
 PLU7024 - 1200x600x730
 PLU7003 - 1400x600x730
 PLU7022 - 1600x600x730
 PLU7026 - 800x700x730
 PLU7027 - 1200x700x730
 PLU7028 - 1400x700x730

PLU7029 - 1600x700x730
 PLU7600 - 1800x700x730
 PLU7025 - 1200x800x730
 PLU7004 - 1400x800x730
 PLU7023 - 1600x800x730
 PLU7601 - 1800x800x730

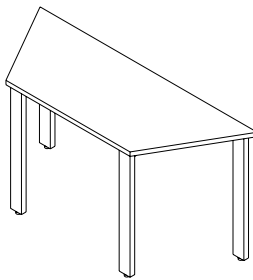

Mesa trapezoidal

PLU7005 - 1400x520x730

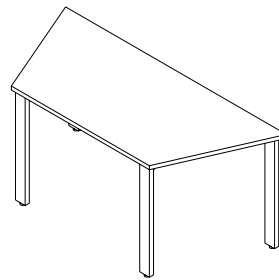

Mesa trapezoidal

PLU7006 - 1600x693x730

Exemplos de layouts de ambientes coletivos (mesa trapezoidal, mesa quadrada e mesa retangular).

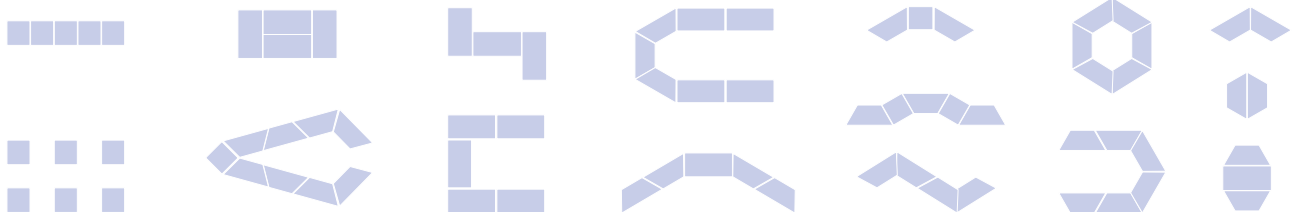

Opções de acabamentos para laminados

- Alumini
- Amêndoa
- Argila
- Branco
- Carvalho Prata
- Grafite
- Málaga
- Noce
- Preto
- Wenge

Opções de acabamentos para metais

- Alumínio
- Argila
- Branco
- Grafite
- Prata
- Preto

bortolini
— por escritórios melhores

www.bortolini.com.br | [f/BortoliniMoveis](https://www.facebook.com/BortoliniMoveis)
Bortolini Indústria de Móveis Ltda - RSC 453 - Km 90 - C. Postal 57 - 95720-000
(54) 3433.2500 - Garibaldi - RS - bortolini@bortolini.com.br